

CAD Drawings - Dual Control

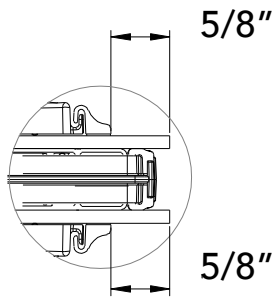

Detail A
Scale=5:1

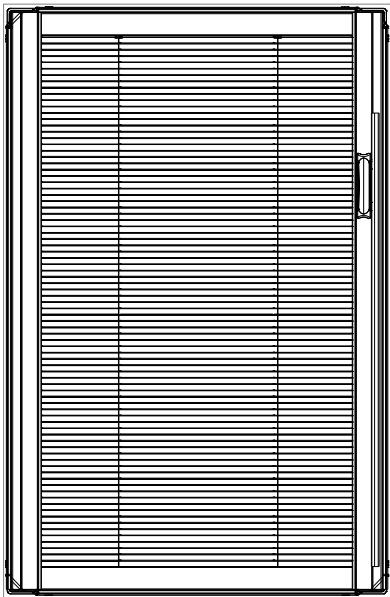
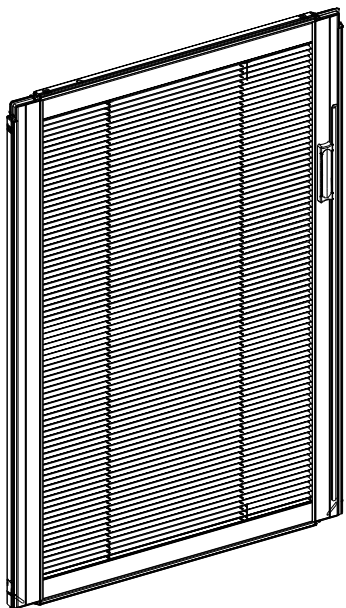

Front Iso View

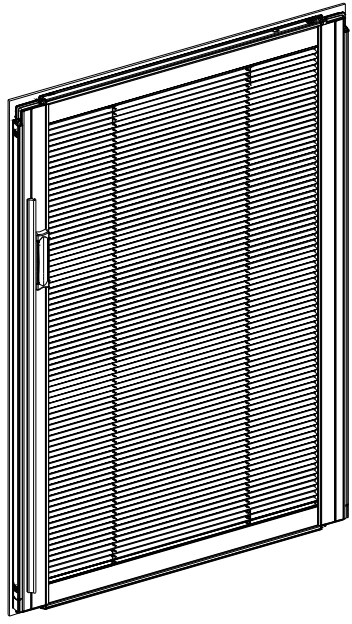

Back Iso View

	DRAWN BY	Franklin	2016-12-23	DESCRIPTION
	ENG APP			Twins Side Tilt Only
DA APP				
<small>© COPYRIGHT 2011 BY CDL INCORPORATED</small> <small>THIS DRAWING IS THE PROPERTY OF CDL. IT IS UNLAWFUL TO REPRODUCE, COPY, OR TRANSMIT IN ANY MANNER WITHOUT THE WRITTEN PERMISSION OF CDL. ANY UNAUTHORIZED USE OF THIS DRAWING IS PROHIBITED.</small>	CRITICAL DIMENSIONS 		3D FILE NAME SE* 1.10	
<small>ACCEPTING THIS DRAWING, THE BUYER AGREES TO HOLD CDL INCORPORATED HARMLESS FROM AND AGAINST ALL CLAIMS, DAMAGES, LOSSES AND EXPENSES, INCLUDING REASONABLE ATTORNEY'S FEES, ARISING OUT OF OR RESULTING FROM THE USE OF THIS DRAWING.</small>	IMPERIAL UNITS .00 ± .01 ANGLE TOL. ± .50° .01 ± .02 DRAFT TOL. ± .25° .1 ± .50		SHEET 1 OF 2 REV. A	
	THIRD ANGLE PROJECTION		SIZE DWG. NO. FILED PRINTED 3/14/2011	

CAD Drawings - Dual Control

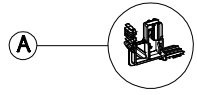
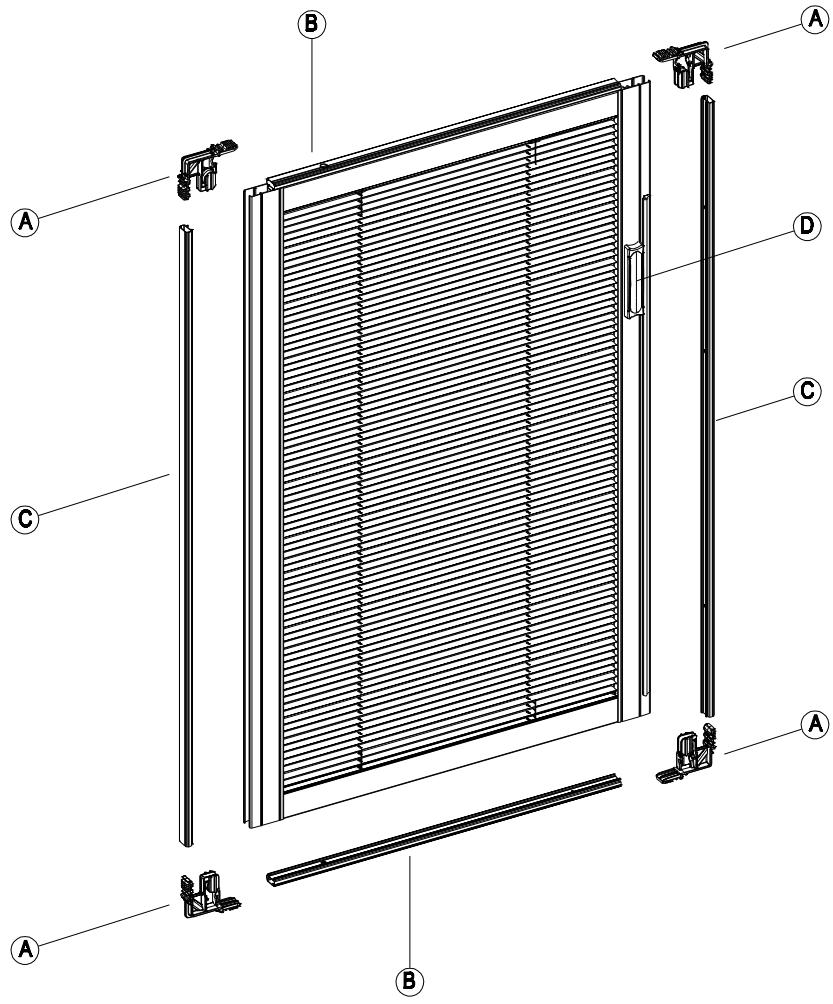

Corner Key

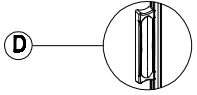

Tilt Operator

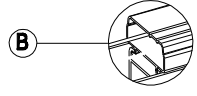

Headrail

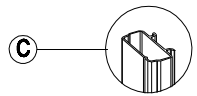

Side Spacer

	DRAWN BY	Franklin	2016-12-23	DESCRIPTION
	ENG APP			Twins Side Tilt Only
	DA APP			
	<small> © COPYRIGHT 2016 FRANKLIN THE DRAWING IS THE PROPERTY OF GDL REPRODUCTION OR DISTRIBUTION WITHOUT EXPRESS PERMISSION IS PROHIBITED. ALL RIGHTS RESERVED. ALL DIMENSIONS ARE IN INCHES UNLESS OTHERWISE SPECIFIED. DIMENSIONS ARE PARALLEL TO THE DRAWING UNLESS OTHERWISE SPECIFIED. DIMENSIONS ARE TO FACE UNLESS OTHERWISE SPECIFIED. DIMENSIONS ARE TO CENTER UNLESS OTHERWISE SPECIFIED. DIMENSIONS ARE TO FACE UNLESS OTHERWISE SPECIFIED. DIMENSIONS ARE TO CENTER UNLESS OTHERWISE SPECIFIED. </small>	CRITICAL DIMENSIONS CONTROL DIMENSIONS IMPERIAL UNITS 000 ± .00 ANGLE TOL. ± .50° .00 ± .20 DRAFT TOL. ± .25° 0 ± .50	30 FILE NAME SIZE DWG NUL SC=1:50 SHEET 2 OF 2 REV. A	
THIRD ANGLE PROJECTION			FILE PRINTED: 3/14/2011	